

Targus®

90W REPLACEMENT LAPTOP CHARGER

410-3546-003A / APA03UK

2 YEAR LIMITED WARRANTY: We pride ourselves on the quality of our products. For complete warranty details and a list of our worldwide offices, please visit www.targus.com

Features and specifications are subject to change without notice. All trademarks and registered trademarks are the property of their respective owners. All rights reserved. ©2017 Manufacturer or Imported by Targus Europe Ltd., Feltham, Middlesex TW14 8HA, UK

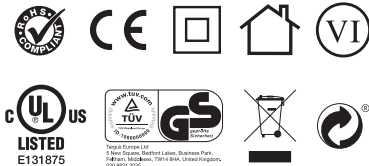

User Guide

Table of Contents

GB – English	3
DE – Deutsch	4
FR – Français	5
CZ – Čeština	6
DK – Dansk	7
FI – Suomi	8
GR – ΕλληνικάΠληροφορίες	9
IT – Italiano	10
NL – Nederlands	11
NO – Norsk	12
PL – Polski	13
PT – Português	14
RU – РусскийИнформация	15

SE – Svenska	16
TR – Türkçe	17
ES – Español	18
AR – العربية	19
BG – Български (език)	20
HR – Hrvatski	21
HU – Magyar	22
LT – Lietuviškai	23
RO – Român	24
SK – Slovenčina	25
SL – Slovensko	26
LV – Latviešu	27
EE – Eesti	28

GB

Introduction

Thank you for purchasing the Targus 90W Replacement Laptop Charger.

Contents

- (A) Targus 90W Replacement Laptop Charger
- (B) UK Power Cord
- (C) 10 Power Tips

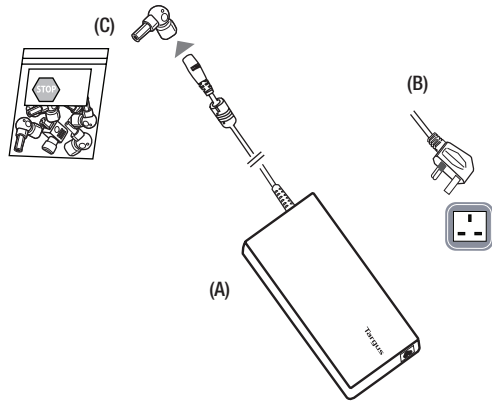

Electrical Rating

90W Replacement Laptop Charger
Input: 100V-240V AC, 50-60Hz, 1.6A
Output: 19V-4.74A, 90W Max

DE

Einführung

Vielen Dank, dass Sie sich für das 90-W-Ersatzladegerät für Notebooks von Targus entschieden haben.

Inhalt

- (A) Targus 90-W-Ersatz-Ladegerät für Notebooks
- (B) Netzkabel UK
- (C) 10 Adapterstecker

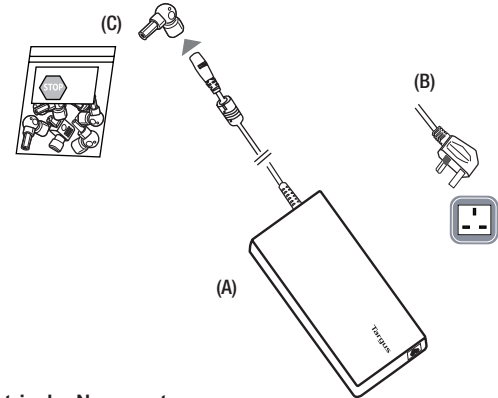

Elektrische Nennwerte

90-W-Ersatz-Ladegerät für Notebooks
Eingang: 100 V-240 V AC, 50-60 Hz, 1,6 A
Ausgang: 19 V-4,74 A, max. 90 W

FR

Introduction

Merci pour votre achat du chargeur de remplacement pour ordinateur portable 90 W de Targus.

Sommaire

- (A) Chargeur de remplacement pour ordinateur portable 90 W de Targus
- (B) Cordon d'alimentation R.-U.
- (C) 10 Connecteurs d'alimentation

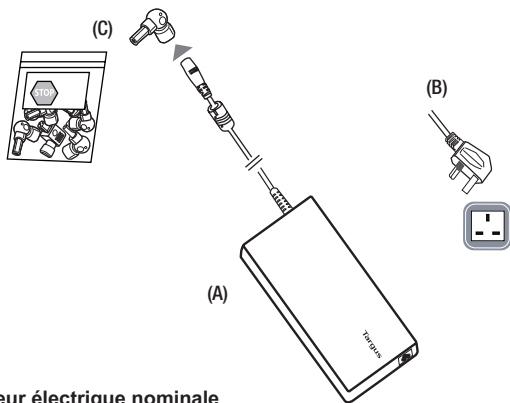

Valeur électrique nominale

Chargeur de remplacement pour ordinateur portable 90 W
Entrée : 100 V-240 V CA, 50-60 Hz, 1,6 A
Sortie : 19 V-4,74 A, 90 W maxi.

CZ

Úvod

Děkujeme Vám za nákup 90W náhradní nabíječky pro notebook Targus.

Obsah

- (A) 90W náhradní nabíječka pro notebook Targus
- (B) UK napájecí kabel
- (C) 10 napájecích hrotů

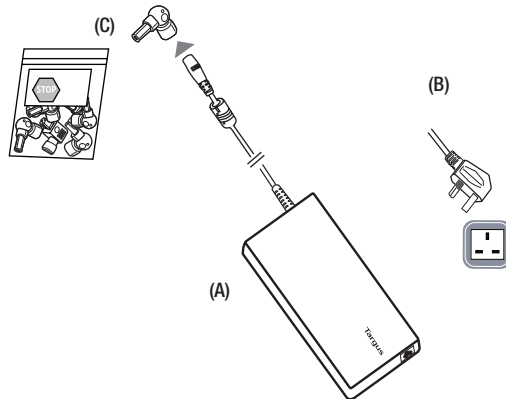

Výpočtový elektrický výkon

90W náhradní nabíječka pro notebook
Vstup: 100 V až 240V, AC, 50 až 60 Hz, 1,6 A
Výstup: 19 V - 4,74 A, max. 90 W

DK

Vejledning

Tak for dit køb af Targus 90W Replacement Laptop oplader.

Indhold

- (A) Targus 90W Replacement Laptop oplader
- (B) UK strømledning
- (C) 10 strømstik

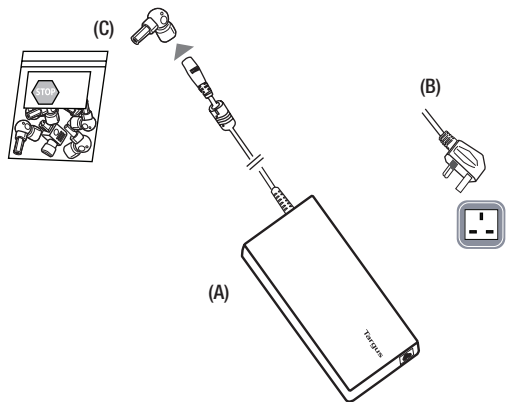

Elektrisk klassificering

90 W Replacement Laptop oplader
Input: 100 V - 240 V AC, 50-60 Hz, 1,6 A
Output: 19 V - 4,74 A, 90 W Maks.

FI

Johdanto

Kiitos Targus 90W Replacement Laptop Charger -laturin ostamisesta.

Sisältö

- (A) Targus 90W Replacement Laptop Charger
- (B) Iso-Britanniassa käytettävä virtajohto
- (C) 10 virransyöttökärkeä

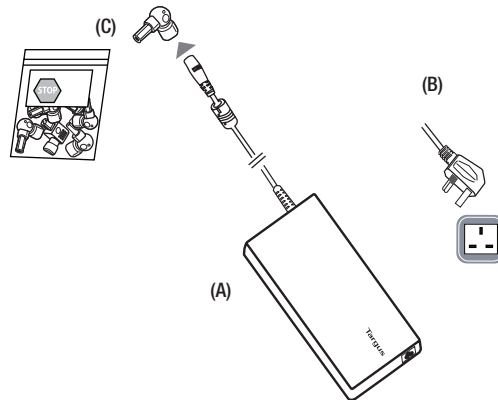

Sähköinen luokitus

90W Replacement Laptop Charger
Tulo: 100-240 V AC, 50-60 Hz, 1,6 A
Lähtö: 19 V, 4,74 A, enintään 90 W

GR

Εισαγωγή

Σας ευχαριστούμε που αγοράσατε τον εφεδρικό φορτιστή Targus 90W για Laptop.

Περιεχόμενα

- (A) Εφεδρικός φορτιστής Targus 90W για Laptop
- (B) Καλώδιο τροφοδοσίας UK
- (Γ) 10 βύσματα τροφοδοσίας

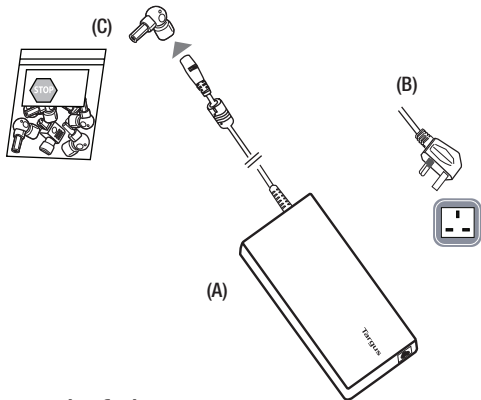

Ηλεκτρική ταξινόμηση

Εφεδρικός φορτιστής 90W για Laptop
Τάση εισόδου: 100V-240V AC, 50-60Hz, 1,6A
Τάση εξόδου: 19V-4,74A, 90W Max

IT

Introduzione

Grazie per avere acquistato il Caricabatterie di ricambio per computer portatile 90W di Targus.

Contenuto

- (A) Caricabatterie di ricambio per computer portatile 90W di Targus
- (B) Cavo di alimentazione UK
- (C) 10 connettori di alimentazione

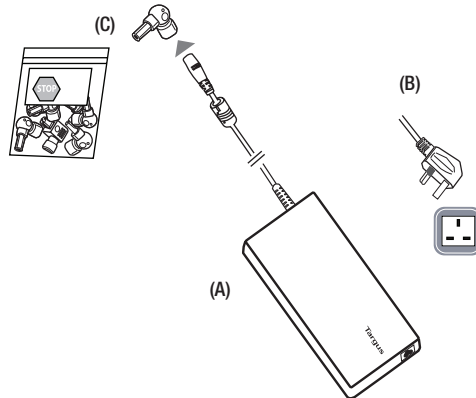

Dati elettrici nominali

Caricabatterie di ricambio per computer portatile 90W
Ingresso: 100V-240V CA, 50-60Hz, 1,6A
Uscita: 19V-4.74A, 90W Max.

NL

Inleiding

Hartelijk dank voor uw aankoop van de Targus vervangende laptplader van 90W.

Inhoud

- (A) Targus vervangende laptplader van 90W
- (B) Engels stroomsnoer
- (C) 10 voedingstips

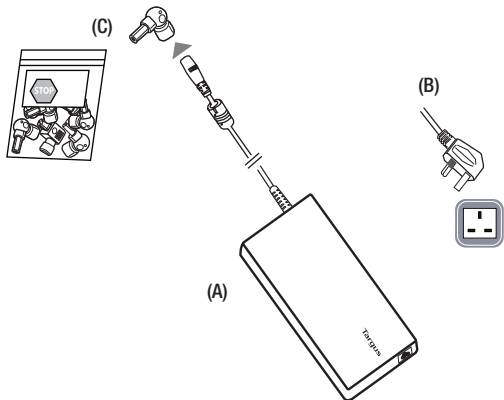

Elektrisch vermogen

Vervangende laptplader van 90W
Ingang: 100V-240VAC, 50-60Hz, 1,6A
Uitgang: 19V-4,74A, 90W max.

NO

Innledning

Takk for kjøpet av Targus 90 W reservelader for bærbare.

Innhold

- (A) Targus 90 W reservelader for bærbare
- (B) Strømledning Storbritannia
- (C) 10 strømtips

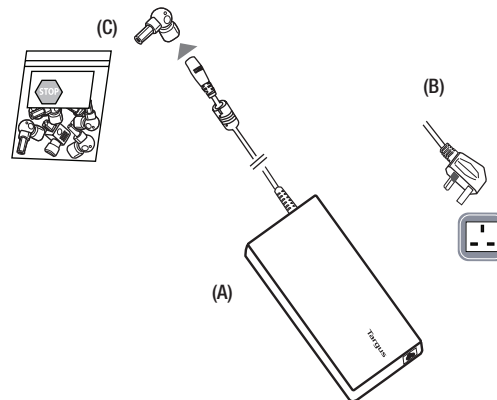

Elektrisitet

90 W reservelader for bærbare
Inngående: 100V-240V AC, 50-60Hz, 1,6A
Ut: 19V-4.74A, 90W Maks

PL

Wprowadzenie

Dziękujemy za zakup zamiennej ładowarki Targus 90W do laptopa.

Zawartość

- (A) Zamienna ładowarka Targus 90W do laptopa
- (B) Przewód zasilający brytyjskiej
- (C) 10 końcówek przewodu zasilającego

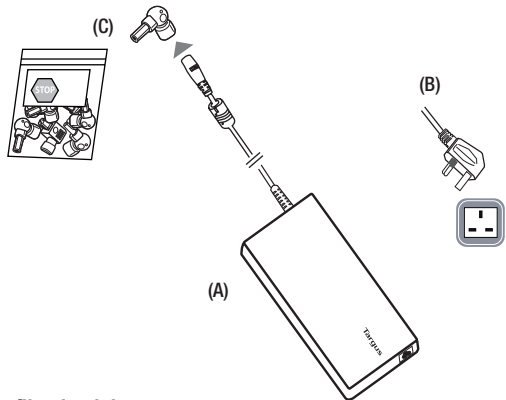

Klasyfikacja elektryczna

Zamienna ładowarka 90W do laptopa
Wejście: 100V-240V AC, 50-60Hz, 1,6A
Wyjście: 19V-4,74A, maks. 90W

PT

Introdução

Obrigado por ter adquirido o Carregador de Substituição de 90 W Targus para Computadores Portáteis.

Conteúdo

- (A) Carregador de Substituição de 90 W Targus para Computadores Portáteis
- (B) Cabo de alimentação UK
- (C) 10 pontas de energia

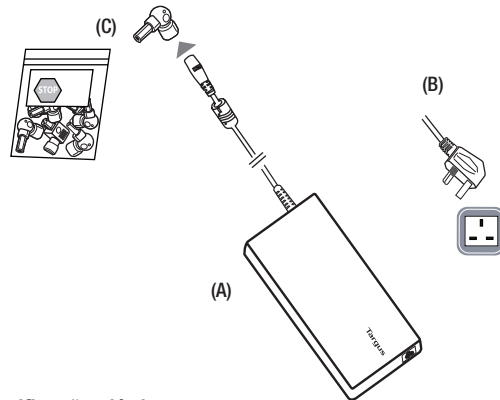

Classificação elétrica

Carregador de Substituição de 90 W para Computadores Portáteis
Entrada: 100 V-240 V CA, 50-60Hz, 1,6 A
Saída: 19 V-4,74 A, 90 W máx.

RU

Вводная информация

Благодарим Вас за приобретение сменного зарядного устройства 90 Вт Targus для ноутбука.

Содержимое

- (A) Сменное зарядное устройство 90 Вт Targus для ноутбука
- (B) Шнур питания британского
- (C) 10 наконечников для зарядки

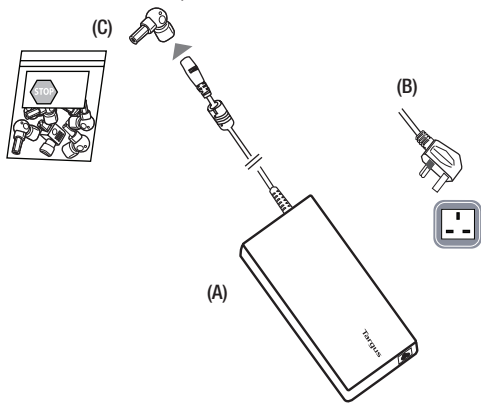

Расчетная электрическая мощность

Сменное зарядное устройство 90 Вт для ноутбука
Вход: 100 В - 240 В перем. тока, 50-60 Гц, 1,6 А
Выход: 19 В - 4,74 А, 90 Вт макс.

SE

“Introduktion”

Tack för att du köpt Targus 90W ersättningsladdare för bärbar dator.

Innehåll

- (A) Targus 90W ersättningsladdare för bärbar dator
- (B) UK-nätkabel
- (C) 10 strömtips

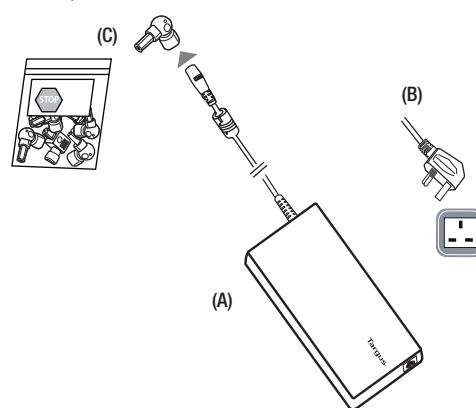

Elektrisk märkning

90W ersättningsladdare för bärbar dator
Ineffekt: 100V-240VAC, 50-60Hz, 1,6A
Output: 19V-4,74A, 90W max

TR

Giriş

Targus 90W Yedek Laptop Şarj Cihazını satın aldığınız için teşekkür ederiz.

İçindekiler

- (A) Targus 90W Yedek Laptop Şarj Cihazı
- (B) UK Güç Kablosu
- (C) Güce İlişkin 10 İpucu

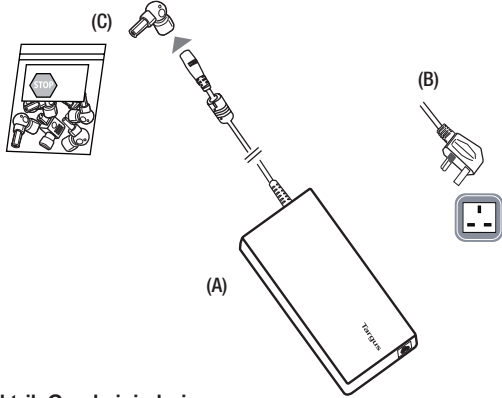

Elektrik Gereksinimleri

90W Yedek Laptop Şarj Cihazı
Giriş: 100V-240VAC, 50-60Hz, 1.6A
Çıkış: 19V-4.74A, 90W Maks.

ES

Introducción

Gracias por adquirir el cargador Targus de sustitución para portátil de 90 W.

Contenido

- (A) Cargador Targus de sustitución para portátil de 90 W
- (B) Cable de alimentación con enchufe británico
- (C) 10 clavijas de toma de alimentación

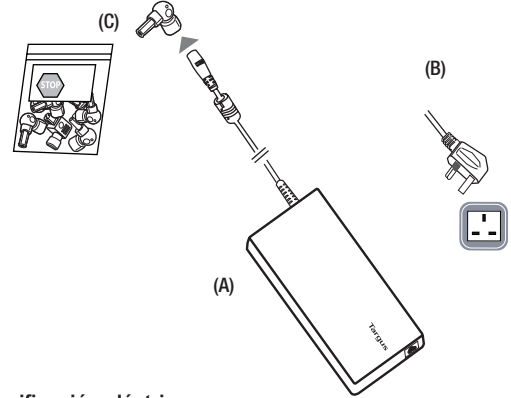

Clasificación eléctrica

Cargador de sustitución para portátil de 90 W
Entrada: 100-240 V CA, 50-60 Hz, 1,6 A
Salida: 19V - 4,74 A, 90 W máx

AR

مقدمة

شكراً لك على شرائك شاحن كمبيوتر محمول بديل 90 واط من تارجوس

المحتويات

- (أ) شاحن كمبيوتر محمول بديل 90 واط من تارجوس
(ب) كابل طاقة للمملكة المتحدة
(ج) 10 أطراف للطاقة

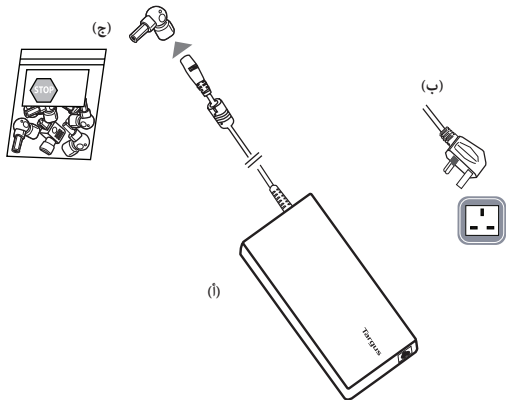

معدل استخدام الطاقة الكهربائية

شاحن كمبيوتر محمول بديل 90 واط
الدخل: 100 فولت - 270 فولت تيار متردد، 50 - هيرتز، 1.6 أمبير
الخرج: 19 فولت - 4.7 أمبير، 90 واط بحد أقصى

BG

Въведение

Благодарим ви, че закупихте заместващо зарядно устройство за лаптоп Targus 90 W.

Съдържание

- (A) Заместващо зарядно устройство за лаптоп Targus 90 W
(Б) Захранващ кабел за Обединеното кралство
(B) 10 накрайника за захранване

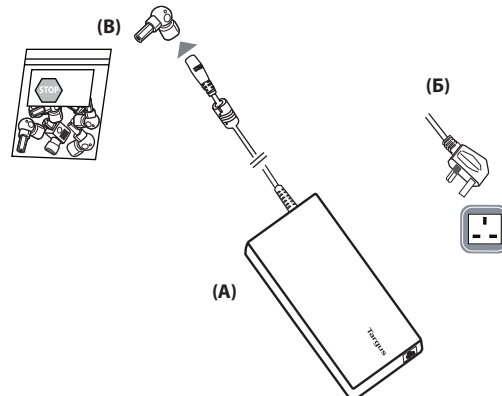

Номинални стойности на електричеството

Заместващо зарядно устройство за лаптоп 90 W
Входящо напрежение: 100 V – 240 V AC, 50 – 60 Hz, 1,6 A
Изходящо напрежение: 19 V – 4,74 A, 90 W макс.

HR

Uvod

Zahvaljujemo na kupnji zamjenskog punjača prijenosnog računala od 90 W tvrtke Targus.

Sadržaj

- (A) Zamjenski punjač prijenosnog računala od 90W tvrtke Targus.
- (B) UK strujni kabel
- (C) 10 savjeta o struji

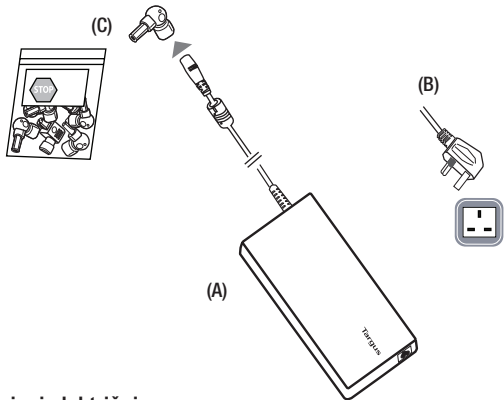

Nazivni električni napon

Zamjenski punjač prijenosnog računala od 90 W
Ulaz: 100 V – 240 V AC, 50 – 60 Hz, 1,6 A
Izlaz: 19 V-4,74 A, 90 W maks.

HU

Bevezetés

Köszönjük, hogy megvásárolta a Targus 90 W-os helyettesítő laptopöltőt.

Tartalom

- (A) Targus 90 W-os helyettesítő laptopöltő
- (B) UK tápkábe
- (C) 10 töltőcsúcs

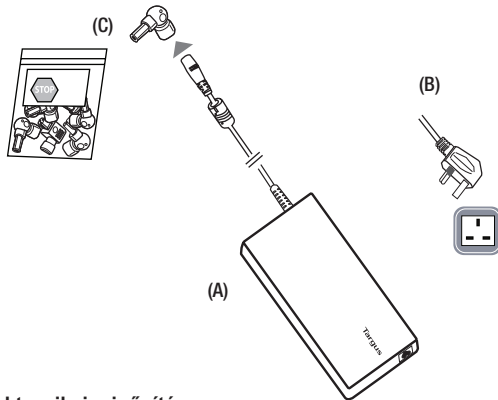

Elektronikai minősítés

90 W-os helyettesítő laptopöltő
Bemenet: 100-240 V AC, 50-60 Hz, 1,6 A
Kimenet: 19 V - 4,74 A, 90 W max.

LT

Įžanga

Dėkojame, kad nusipirkote „Targus“ atsarginį nešiojamojo kompiuterio 90 W įkroviklį.

Sudėtinės dalys

- (A) „Targus“ atsarginis nešiojamojo kompiuterio 90 W įkroviklis
- (B) JK maitinimo laidas
- (C) 10 maitinimo antgalių

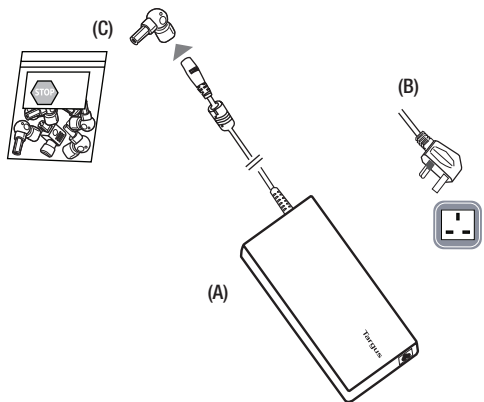

Elektros charakteristikos

Atsarginis nešiojamojo kompiuterio 90 W įkroviklis
Įvadas: 100–240 V kint. srovė, 50–60 Hz, maks. 1,6 A
Išvadas: 19–4,74 A, maks. 90 W

RO

Introducere

Vă mulțumim pentru achiziționarea încărcătorului de schimb Targus pentru laptop, de 90 W.

Conținut

- (A) Încărcător de schimb Targus pentru laptop, 90 W
- (B) cablu de alimentare tip UK
- (C) 10 mufe de alimentare

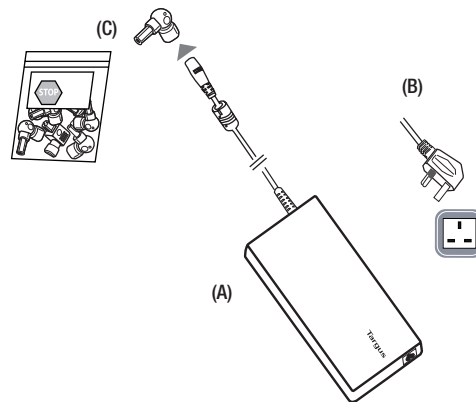

Putere nominală

Încărcător de schimb pentru laptop, 90 W
Intrare: 100V-240VCA, 50-60Hz, 1,6A
Ieșire: 19 V - 4,74 A, 90 W Max

SK

Úvod

Ďakujeme, že ste si kúpili Targus 90W náhradnú nabíjačku na notebook.

Obsah

- (A) Targus 90W náhradná nabíjačka na notebook
- (B) Sieťový kábel UK
- (C) 10 sieťových koncoviek

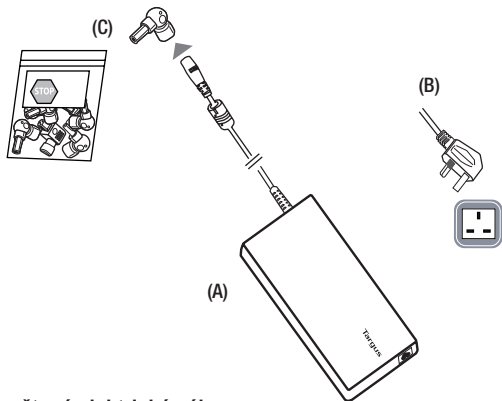

Výpočtový elektrický výkon

90W Náhradná nabíjačka na notebook
Vstup: 100 V – 240 V AC, 50 – 60 Hz, 1,6 A
Výstup: 19 V – 4,74 A, 90 W max

SL

Uvod

Zahvaljujemo se vam za nakup nadomestnega napajalnika Targus 90 W.

Vsebina

- (A) Nadomestni napajalnik Targus za prenosni računalnik 90 W
- (B) Napajalni kabel z UK- priključkom
- (C) 10 nasvetov za polnjenje

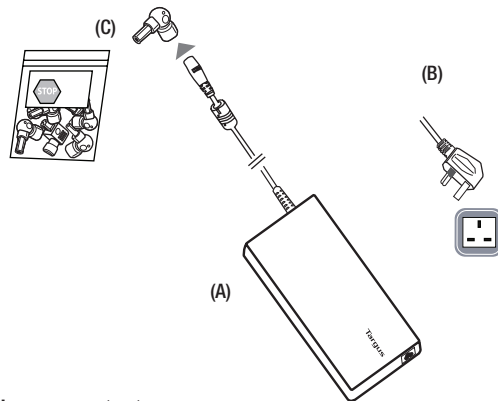

Delovna napetost

Nadomestni napajalnik za prenosni računalnik 90 W
Vhodna napetost: 100–240 V AC, 50–60 Hz, 1,6 A
Izhodna napetost: 19 V–4,74 A, najv. 90 W

LV

Ievads

Paldies, ka iegādājāties Targus 90W klēpjdatora maiņas lādētāju.

Saturs

- (A) Targus 90 W klēpjdatora maiņas lādētājs
- (B) AK strāvas vads
- (C) 10 padomi saistībā ar strāvu

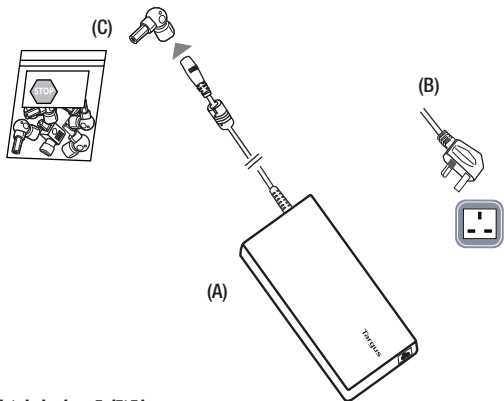

Elektriskais rādītājs

90W klēpjdatora maiņas lādētājs
Ievade: 100V-240VAC, 50-60Hz, 1,6A
Izeja: 19V-4,74A, maks. 90W

EE

Tutvustus

Tānāme teid Targuse 90 W sūleavuti asenduslādija ostmise eest.

Sisu

- (A) Targuse 90 W asenduslādija sūleavutile
- (B) ŪK toitejuhe
- (C) 10 juhtmeotsakut

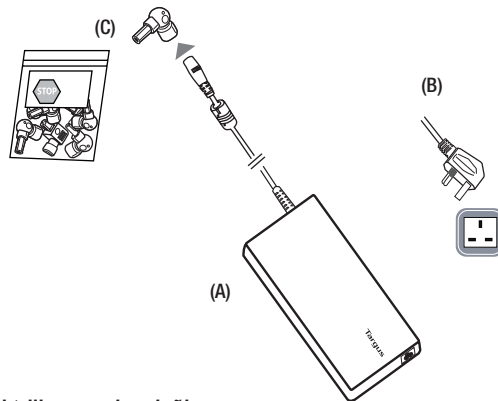

Elektriline nominaalvõimsus

90 W asenduslādija sūleavutile
Toide: 100V-240VAC, 50-60Hz, 1,6A
Võimsus: 19V-4,74A, 90W max

Technical Support

For technical questions, please visit:

Internet

English <http://www.targus.com/uk/support>
French <http://www.targus.com/fr/support>
German <http://www.targus.com/de/support>
Spanish <http://www.targus.com/es/support>

Telephone

Austria	+43 1-795-676-42	Norway	+47 022577729
Belgium	+32 (0)2-717-2451	Portugal	+351 21-415-4123
Denmark	+45 35-25-87-51	Spain	+34 91-745-6221
Finland	+358 (0)922948016	Sweden	+46 (0)8-751-4058
France	+33 (0)1-6453-9151	Switzerland	+41 44-212-0007
Germany	+49 (0)211-6579-1151	United Kingdom	+44 (0)20-7744-0330
Italy	+39 02-4827-1151	Eastern Europe & others	+44 (0)20-7744-0330
Netherlands	+31 (0)20-504671		

Warranty

2 YEAR LIMITED WARRANTY: We pride ourselves on the quality of our products. For complete warranty details and a list of our worldwide offices, please visit www.targus.com

Features and specifications are subject to change without notice. All trademarks and registered trademarks are the property of their respective owners. All rights reserved. ©2017 Manufacturer or Imported by Targus Europe Ltd., Feltham, Middlesex TW14 8HA, UK

Regulatory Compliance (applicable to products with electronic circuitry/parts only)

This device complies with Part 15 of the FCC Rules. Operation is subject to the following two conditions: (1) This device may not cause harmful interference, and (2) this device must accept any interference received, including interference that may cause undesired operation.

FCC Statement

Tested to Comply

This equipment has been tested and found to comply with the limits of a Class B digital device, pursuant to Part 15 of the FCC Rules. These limits are designed to provide reasonable protection against harmful interference in a residential installation. This equipment generates, uses, and can radiate radio frequency energy, and if not installed and used in accordance with the instructions may cause harmful interference to radio communications. However, there is no guarantee that interference will not occur in a particular installation. If this equipment does cause harmful interference to radio or television reception, which can be determined by turning the equipment off and on, the user is encouraged to try to correct the interference by one or more of the following measures:

- Reorient or relocate the receiving antenna;
- Increase the separation between the equipment and receiver;
- Connect the equipment into an outlet on a circuit different from that to which the receiver is connected;
- Consult the dealer or an experienced radio/TV technician for help

Changes or modifications not authorized by the party responsible for compliance could void the user's authority to operate this product.

Declaration of Conformity

Targus hereby declares that this device is in compliance with the essential requirements and other relevant provisions of Directive 2014/30/EU.

Targus Recycling Directive

At the end of this product's useful life please dispose at an appropriate recycling collection point provided in your country.